



COB LED STRIP LIGHT PRODUCT SPECIFICATION



Key Feature

- ◆ LM-80 approved LED 50,000 hours
- ◆ Lifetime, 5 years warranty
- ◆ Multiple Color Option : 3000K ~ 4000K
- ◆ Light Spotless,flexible
- ◆ CRI Option: Ra>80, Ra>90, Ra>95 all available



Drawing:

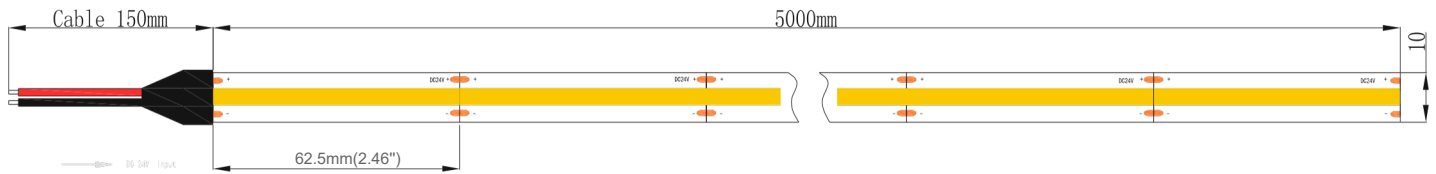

Notice:

Safety Input Voltage: DC 24V

Size of each section is 62.5mm and cutting at "scissors symbol" place.

LED Strip length's length tolerance is $\pm 0.2\%$ mm, width tolerance is ± 0.2 mm.

Optical

LED type:	Flip Chip
Color rendering index:	R a>80 R a>90
CCT Range:	3000K, 3500K, 4000K,
Irradiation angle	180°
Light Efficiency:	95~110 Lm/w
Lumen output/meter:	1425~1650Lm/m(435~500Lm/ft)

Electric (24V)

Input current/m:	0.625A/m(0.19A/ft)
Input Voltage:	DC24V
Voltage Power/m:	15W/m(4.5W/ft)
Static Electricity:	1000V(ESD)
LEDs/meter:	512LEDs/m
Size of section:	62.5mm(2.46")
LEDs cut section:	32LEDs

Others

Energy grade:	F
Warranty:	5years
Working hour:	50,000hrs lifetime for Tc<70°C
Working temperature:	-20°C ~ +45°C
Working humidity:	40%-70%RH
Measurement:	L5000*W10mm 16.4ft*0.4in
Ingress Protection Rating:	IP20

Descriptions:

- LED Strip can be used in many kinds of places as decorative lighting/backlight/ such as Ceiling trough, Staircase, Hall walkway, Billboard,

Ingress Protection Rating :

IP Rate Description :

IP20 : Indoor use

IP67: Lead-free and mercury-free, Strong adhesion

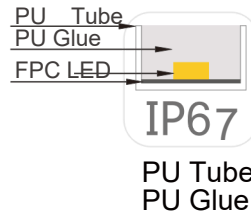
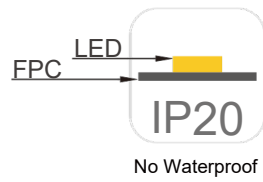

Wiring diagram application :

◆ Single end power input for 5 meters

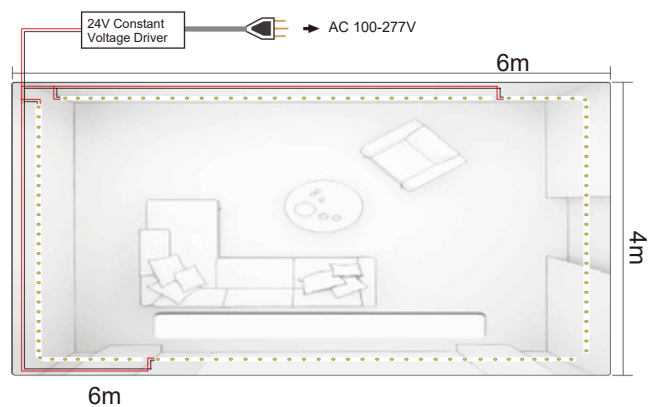
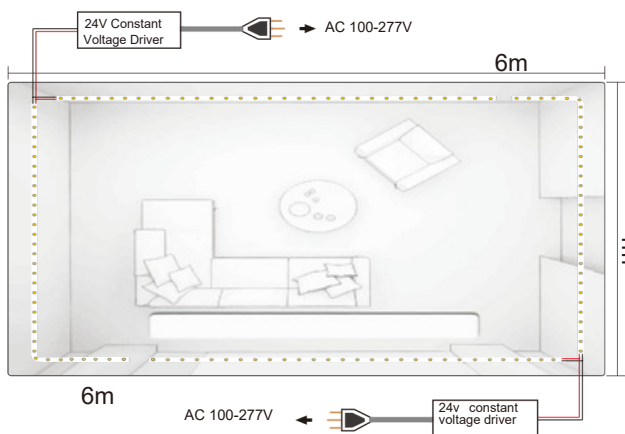
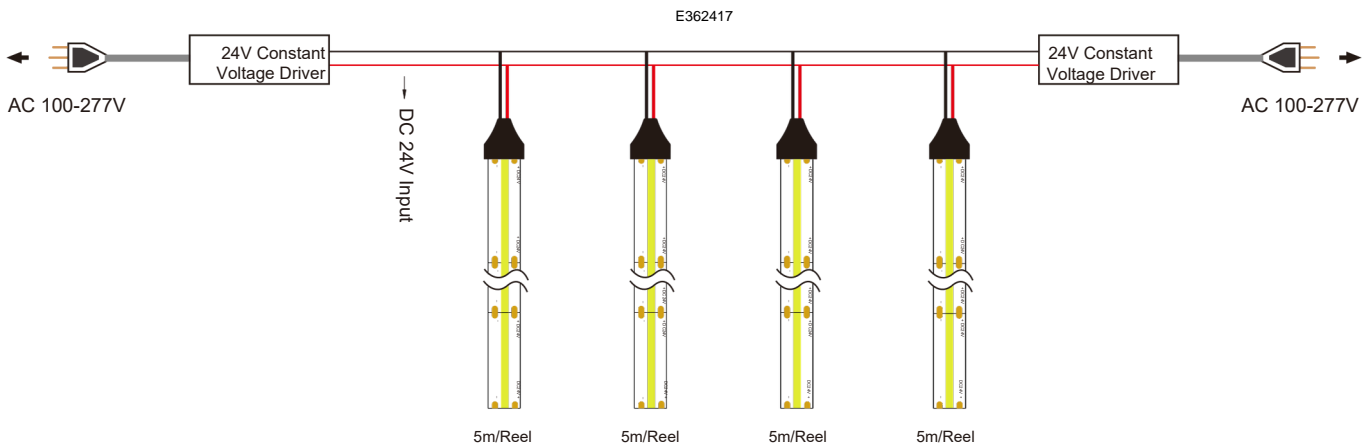

3M Adhesive Tape



3M 300 LSE 9495

Aluminium foil



Plastic reel

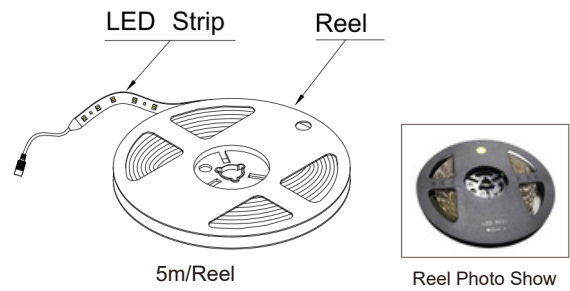

Carton box

Packing Number

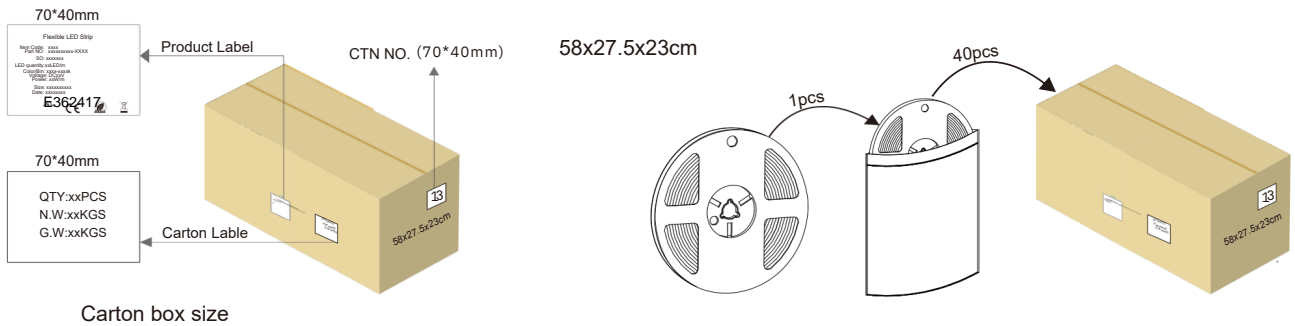

Strip Code :

Item code	LEDs/m	Voltage	Power (W/m)	CCT	CRI	Lumens Output (Lm/m)	IP Grade
AV-COB-24V-500L-3000K	512LEDs	24V	15W	3000K	90+	1425Lm	IP20
AV-COB-24V-500L-3500K	512LEDs	24V	15W	3500K	90+	1500Lm	IP20
AV-COB-24V-500L-4000K	512LEDs	24V	15W	4000K	90+	1650Lm	IP20



Cautions:

≤50 mm diameter of wrapped object prohibited

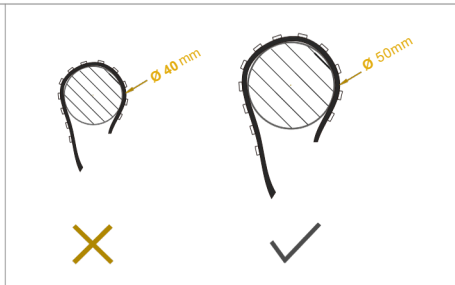

Touching LED, pls wear the electrostatic ring for avoiding ESD

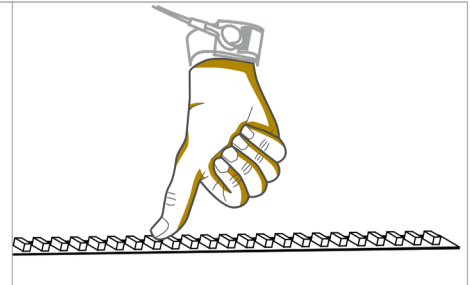

Safety Information

Application notes for led exiable strip

In order to drive LED flexible strip lights safely, it is absolutely necessary to operate them with an electronically stabilised power supply protecting against short circuits, overload and overheating.

To also ease the luminaire/installation approval, electronic control gear, power supply and all electronic accessories for LED or LED modules should carry "CE, or UL" mark and meet the latest safety standard.

- Please use 24VDC isolated power supply to drive the led strip, and the constant voltage source ripple less than 5%. Can't step-down the power by resistance-capacitance and nun-isolated power supply driver led strip, etc.
- To ensure the longevity and reliability of the strips, please do not bend the arc diameter 60mm or less, do not fold to avoid damaging the lamp beads or broken.
- To ensure the life and environment of lights, in the use of force can not pull the power cord to avoid damage to prohibit collision L
- During the installation of positive and negative attention to the power cord, do not pick the wrong voltage power supply and the product are the same, so as to avoid damage to the product.
- LED lights should be stored in dry sealed environment, the proposed storage period should not be too long before using unpacking, the working temperature: -20 ~ + 45 , Storage temperature: -0 ~ + 60 , not waterproof lights band indoor use, relative humidity not higher than 70%.
- In practical applications, the power supply should leave 20% margin (recommend using only 80% of the power) in order to ensure a suf cient amount of voltage drive products
- Do not use any acidic, alkaline adhesive securement products (including not limited to glass, plastic, etc.)